

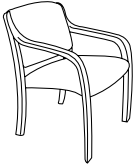



**PRODUCT FEATURES:**

- › Laminated Beech frame.
  - › Open or closed upholstered backs.
  - › Multiple configurations of seating and tables.
  - › All standard tables are Maple veneer with Maple hardwood edges.
  - › Four table options. Custom table sizes available, contact Customer Service for pricing.
  - › Laminate tops available.
  - › All standard finishes available on Beech and Maple.
  - › For custom wood finishes, please add one-time upcharge of \$200 List per color per order.
- › Note: Please include seating layout drawings or sketch with each order.
  - › For moisture barrier on seats only, add \$40 List per seat and specify “-MB”.
  - › Non-skid glides available for hard surface floors. Please specify “NS” after model number and add \$5 List per leg.

MODEL #		FABRIC GRADES								LEATHER GRADES			
		COM	1	2	COL			4	5	6	7	8	L1
<b>1150</b>	 <p><b>Side Chair</b>  <b>Open Back, 4-Leg</b>                      W 23<sup>1</sup>/<sub>2</sub> D 25<sup>1</sup>/<sub>2</sub> H 33                      status  761 815 833 851 869 887 905 923 941 1151 1249 1346                      Seat Ht. 18                      Inside Seat Width 20                      Inside Seat Depth 18                      Arm Ht. 25<sup>1</sup>/<sub>2</sub>                      1<sup>1</sup>/<sub>2</sub> Yds. 35 lbs.                      TB 133, add \$60 List</p>												
<b>1150-2</b>	 <p><b>Open Back, 2-Seater</b>                      W 45<sup>1</sup>/<sub>2</sub> D 25<sup>1</sup>/<sub>2</sub> H 33                      1401 1509 1545 1581 1617 1653 1689 1725 1761 2181 2376 2571                      Seat Ht. 18                      Inside Seat Width 20                      Inside Seat Depth 18                      Arm Ht. 25<sup>1</sup>/<sub>2</sub>                      3 Yds. 72 lbs.                      TB 133, add \$120 List</p>												
<b>1150-3</b>	 <p><b>Open Back, 3-Seater</b>                      W 67 D 25<sup>1</sup>/<sub>2</sub> H 33                      2005 2167 2221 2275 2329 2383 2437 2491 2545 3175 3467 3760                      Seat Ht. 18                      Inside Seat Width 20                      Inside Seat Depth 18                      Arm Ht. 25<sup>1</sup>/<sub>2</sub>                      4<sup>1</sup>/<sub>2</sub> Yds. 93 lbs.                      TB 133, add \$180 List</p>												
<b>1150-4</b>	 <p><b>Open Back, 4-Seater</b>                      W 88<sup>1</sup>/<sub>2</sub> D 25<sup>1</sup>/<sub>2</sub> H 33                      2632 2848 2920 2992 3064 3136 3208 3280 3352 4192 4582 4972                      Seat Ht. 18                      Inside Seat Width 20                      Inside Seat Depth 18                      Arm Ht. 25<sup>1</sup>/<sub>2</sub>                      6 Yds. 114 lbs.                      TB 133, add \$240 List</p>												

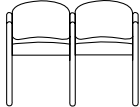
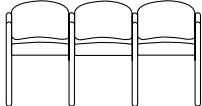
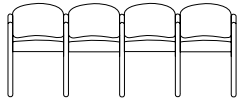
**PRODUCT FEATURES:**

- > Laminated Beech frame.
  - > Open or closed upholstered backs.
  - > Multiple configurations of seating and tables.
  - > All standard tables are Maple veneer with Maple hardwood edges.
  - > Four table options. Custom table sizes available, contact Customer Service for pricing.
  - > Laminate tops available.
  - > All standard finishes available on Beech and Maple.
  - > For custom wood finishes, please add one-time upcharge of \$200 List per color per order.
- > Note: Please include seating layout drawings or sketch with each order.
  - > For moisture barrier on seats only, add \$40 List per seat and specify "-MB".
  - > Non-skid glides available for hard surface floors. Please specify "NS" after model number and add \$5 List per leg.

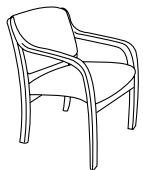
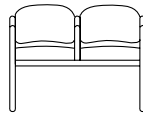
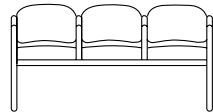
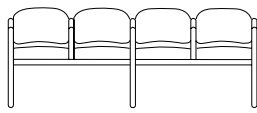

GUEST SEATING

MODEL #		FABRIC GRADES							LEATHER GRADES				
		COM	1	2	COL			6	7	8	L1	L2	L3
1152	 <p><b>Side Chair Open Back on Beam</b> W 23<sup>1</sup>/<sub>2</sub> D 25<sup>1</sup>/<sub>2</sub> H 33 Seat Ht. 18 Inside Seat Width 20 Inside Seat Depth 18 Arm Ht. 25<sup>1</sup>/<sub>2</sub> 1<sup>1</sup>/<sub>2</sub> Yds. 43 lbs. TB 133, add \$60 List</p>	829	883	901	919	937	955	973	991	1009	1219	1316	1414
1152-2	 <p><b>Open Back, 2-Seater on Beam</b> W 45<sup>1</sup>/<sub>2</sub> D 25<sup>1</sup>/<sub>2</sub> H 33 Seat Ht. 18 Inside Seat Width 20 Inside Seat Depth 18 Arm Ht. 25<sup>1</sup>/<sub>2</sub> 3 Yds. 78 lbs. TB 133, add \$120 List</p>	1469	1577	1613	1649	1685	1721	1757	1793	1829	2249	2444	2639
1152-3	 <p><b>Open Back, 3-Seater on Beam</b> W 67 D 25<sup>1</sup>/<sub>2</sub> H 33 Seat Ht. 18 Inside Seat Width 20 Inside Seat Depth 18 Arm Ht. 25<sup>1</sup>/<sub>2</sub> 4<sup>1</sup>/<sub>2</sub> Yds. 102 lbs. TB 133, add \$180 List</p>	2071	2233	2287	2341	2395	2449	2503	2557	2611	3241	3534	3826
1152-4	 <p><b>Open Back, 4-Seater on Beam</b> W 88<sup>1</sup>/<sub>2</sub> D 25<sup>1</sup>/<sub>2</sub> H 33 Seat Ht. 18 Inside Seat Width 20 Inside Seat Depth 18 Arm Ht. 25<sup>1</sup>/<sub>2</sub> 6 Yds. 126 lbs. TB 133, add \$240 List</p>	2697	2913	2985	3057	3129	3201	3273	3345	3417	4257	4647	5037



**PRODUCT FEATURES:**

- › Laminated Beech frame.
  - › Open or closed upholstered backs.
  - › Multiple configurations of seating and tables.
  - › All standard tables are Maple veneer with Maple hardwood edges.
  - › Four table options. Custom table sizes available, contact Customer Service for pricing.
  - › Laminate tops available.
  - › All standard finishes available on Beech and Maple.
  - › For custom wood finishes, please add one-time upcharge of \$200 List per color per order.
- › Note: Please include seating layout drawings or sketch with each order.
  - › For moisture barrier on seats only, add \$40 List per seat and specify “-MB”.
  - › Non-skid glides available for hard surface floors. Please specify “NS” after model number and add \$5 List per leg.

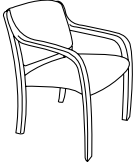
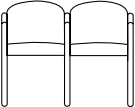
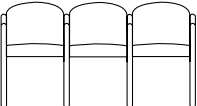
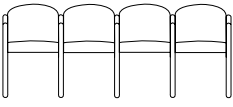
MODEL #		FABRIC GRADES							LEATHER GRADES				
		COM	1	2	COL 3	4	5	6	7	8	L1	L2	L3
1155	 <p><b>Side Chair Closed Back, 4-Leg</b> W 23<sup>1</sup>/<sub>2</sub> D 25<sup>1</sup>/<sub>2</sub> H 33 Seat Ht. 18 Inside Seat Width 20 Inside Seat Depth 18 Arm Ht. 25<sup>1</sup>/<sub>2</sub> 1<sup>1</sup>/<sub>2</sub> Yds. 35 lbs. TB 133, add \$60 List</p>	761	815	833	851	869	887	905	923	941	1151	1249	1346
1155-2	 <p><b>Closed Back, 2-Seater</b> W 45<sup>1</sup>/<sub>2</sub> D 25<sup>1</sup>/<sub>2</sub> H 33 Seat Ht. 18 Inside Seat Width 20 Inside Seat Depth 18 Arm Ht. 25<sup>1</sup>/<sub>2</sub> 3 Yds. 72 lbs. TB 133, add \$120 List</p>	1401	1509	1545	1581	1617	1653	1689	1725	1761	2181	2376	2571
1155-3	 <p><b>Closed Back, 3-Seater</b> W 67 D 25<sup>1</sup>/<sub>2</sub> H 33 Seat Ht. 18 Inside Seat Width 20 Inside Seat Depth 18 Arm Ht. 25<sup>1</sup>/<sub>2</sub> 4<sup>1</sup>/<sub>2</sub> Yds. 93 lbs. TB 133, add \$180 List</p>	2005	2167	2221	2275	2329	2383	2437	2491	2545	3175	3467	3760
1155-4	 <p><b>Closed Back, 4-Seater</b> W 88<sup>1</sup>/<sub>2</sub> D 25<sup>1</sup>/<sub>2</sub> H 33 Seat Ht. 18 Inside Seat Width 20 Inside Seat Depth 18 Arm Ht. 25<sup>1</sup>/<sub>2</sub> 6 Yds. 114 lbs. TB 133, add \$240 List</p>	2632	2848	2920	2992	3064	3136	3208	3280	3352	4192	4582	4972

**PRODUCT FEATURES:**

- › Laminated Beech frame.
  - › Open or closed upholstered backs.
  - › Multiple configurations of seating and tables.
  - › All standard tables are Maple veneer with Maple hardwood edges.
  - › Four table options. Custom table sizes available, contact Customer Service for pricing.
  - › Laminate tops available.
  - › All standard finishes available on Beech and Maple.
  - › For custom wood finishes, please add one-time upcharge of \$200 List per color per order.
- › Note: Please include seating layout drawings or sketch with each order.
  - › For moisture barrier on seats only, add \$40 List per seat and specify “-MB”.
  - › Non-skid glides available for hard surface floors. Please specify “NS” after model number and add \$5 List per leg.



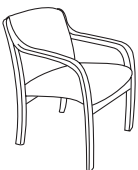
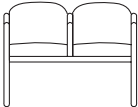
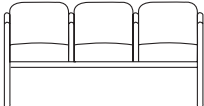
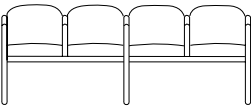

GUEST SEATING

MODEL #		FABRIC GRADES							LEATHER GRADES				
		COM	1	2	COL 3	4	5	6	7	8	L1	L2	L3
1157	 <p><b>Side Chair Closed Back on Beam</b> W 23<sup>1</sup>/<sub>2</sub> D 25<sup>1</sup>/<sub>2</sub> H 33 Seat Ht. 18 Inside Seat Width 20 Inside Seat Depth 18 Arm Ht. 25<sup>1</sup>/<sub>2</sub> 1<sup>1</sup>/<sub>2</sub> Yds. 43 lbs. TB 133, add \$60 List</p>	829	883	901	919	937	955	973	991	1009	1219	1316	1414
1157-2	 <p><b>Closed Back, 2-Seater on Beam</b> W 45<sup>1</sup>/<sub>2</sub> D 25<sup>1</sup>/<sub>2</sub> H 33 Seat Ht. 18 Inside Seat Width 20 Inside Seat Depth 18 Arm Ht. 25<sup>1</sup>/<sub>2</sub> 3 Yds. 78 lbs. TB 133, add \$120 List</p>	1469	1577	1613	1649	1685	1721	1757	1793	1829	2249	2444	2639
1157-3	 <p><b>Closed Back, 3-Seater on Beam</b> W 67 D 25<sup>1</sup>/<sub>2</sub> H 33 Seat Ht. 18 Inside Seat Width 20 Inside Seat Depth 18 Arm Ht. 25<sup>1</sup>/<sub>2</sub> 4<sup>1</sup>/<sub>2</sub> Yds. 102 lbs. TB 133, add \$180 List</p>	2071	2233	2287	2341	2395	2449	2503	2557	2611	3241	3534	3826
1157-4	 <p><b>Closed Back, 4-Seater on Beam</b> W 88<sup>1</sup>/<sub>2</sub> D 25<sup>1</sup>/<sub>2</sub> H 33 Seat Ht. 18 Inside Seat Width 20 Inside Seat Depth 18 Arm Ht. 25<sup>1</sup>/<sub>2</sub> 6 Yds. 126 lbs. TB 133, add \$240 List</p>	2697	2913	2985	3057	3129	3201	3273	3345	3417	4257	4647	5037

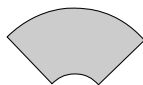

**PRODUCT FEATURES:**

- > All standard tables are Maple veneer with Maple hardwood edges.
- > Four table options. Custom table sizes available, contact Customer Service for pricing.
- > Laminate tops available.
- > Tables are field installed.
- > All standard finishes available on Maple.
- > For custom wood finishes, please add one-time upcharge of \$200 List per color per order.
- > Note: Please include seating layout drawings or sketch with each order.

MODEL #		LIST					
1170	 <p><b>20" Table Top In Line Add-On</b> W 20 D 18<sup>1</sup>/<sub>2</sub> 15 lbs. Field Installed</p>	399					
1175	 <p><b>Corner Table Right Angle Add-On</b> W 24 D 24 20 lbs. Field Installed</p>	462					
1180-R	 <p><b>Right End Table (Facing)</b> W 24 D 18<sup>1</sup>/<sub>2</sub> H 16<sup>1</sup>/<sub>4</sub> 23 lbs. Field Installed</p>	488					
1180-L	 <p><b>Left End Table (Facing)</b> W 24 D 18<sup>1</sup>/<sub>2</sub> H 16<sup>1</sup>/<sub>4</sub> 23 lbs. Field Installed</p>	488					



SAMPLE LAYOUTS WITH DIMENSIONS

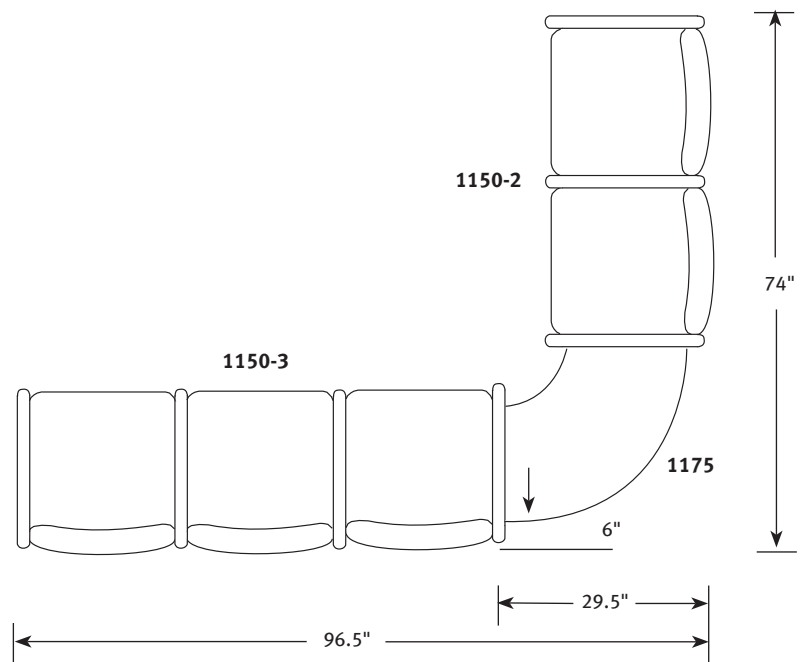
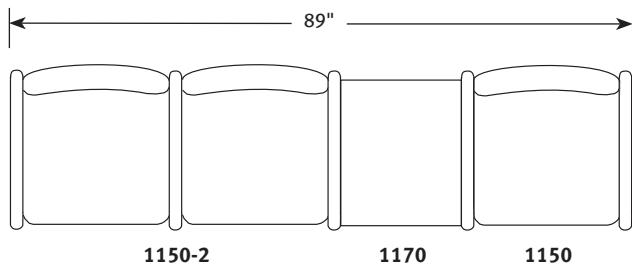

Please furnish sketch or drawing with each order.